



深圳开源通信有限公司

*OpenVox-Best Cost Effective Asterisk Cards*

OpenVox A2410P/AE2410P on Elastix 2.0

User Manual

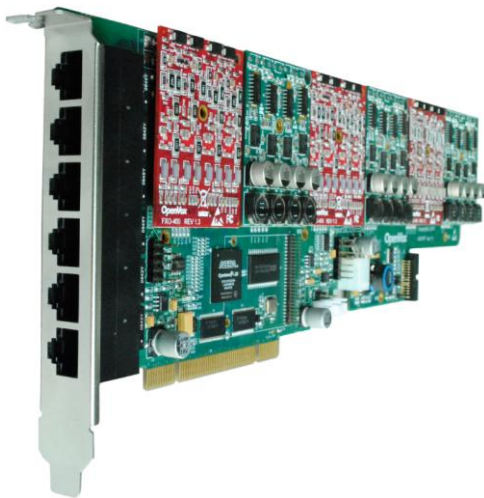

A2410P

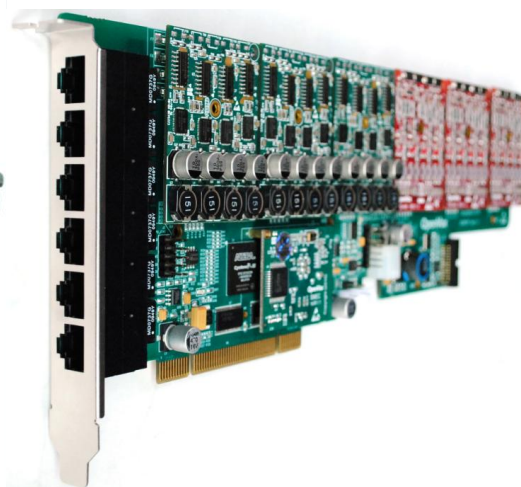

AE2410P

*Date:15/09/2010*

*Version: 1.1*



深圳开源通信有限公司

*OpenVox-Best Cost Effective Asterisk Cards*

OpenVox Communication Co. Ltd.

Address: F/3, Block No.127, Jindi Industrial Zone,  
Shazui Road, Futian district, ShenZhen, Guangdong 518048, China

Tel:+86-755-82535095, 82535461, Fax:+86-755-82535174

E-Mail: [sales@openvox.cn](mailto:sales@openvox.cn) [support@openvox.cn](mailto:support@openvox.cn)

IM for Technical Support: [support@openvox.cn](mailto:support@openvox.cn) [James.zhu@openvox.cn](mailto:James.zhu@openvox.cn)

Business Hours: 9:00AM-18:00PM from Monday-Friday

URL: [www.openvox.cn](http://www.openvox.cn)

*Thank You for Choosing OpenVox Products!*

---

## Table of Contents

<b>1. Overview</b> .....	<b>4</b>
1.1 What is A2410P/AE2410P.....	4
1.2 What is Asterisk:.....	5
<b>2. Hardware Setting</b> .....	<b>6</b>
<b>3. Software Installation and Configuration</b> .....	<b>8</b>
3.1 Download dahdi and driver.....	8
3.2 Edit the configure file.....	8
3.3 Installation.....	10
3.4 Configure.....	11
<b>4. Configure on Elastix webpage</b> .....	<b>16</b>
4.1 Log into Elastix Webpage.....	16
4.2 Create Extensions.....	16
4.3 Add Incoming Route.....	19
4.4 Create Trunk.....	20
4.5 Set up Outbound Route.....	21
<b>5. References</b> .....	<b>23</b>

## 1. Overview

### 1.1 What is A2410P/AE2410P

A2410P is a modular analog telephony interface product. AE2410P is A2410P with EC module. It is designed to build IP PBX.

A2410P/AE2410P must be used with FX0-400 or FXS-400 together to build a workable system. AE2410P has EC module, which must be used with FX0-400 or FXS-400 together.

#### Key Benefits:

Low CPU Payload : Firmware accelerate I/O access achieve high stability and highly decreased cpu payload

Scalable: Just add additional cards to extend system

Bus Master: Operation speed up to 132Mbytes/sec

Echo cancellation: Support high quality octasic echo cancellation DSP, each channel independent of 128ms or 1024 taps echo cancellation

RoHS compliant

Certificates: CE, FCC

#### Misc:

Temperature Operation: 0 to 50° C

Temperature Storage: -40 to 125° C

Humidity: 10 TO 90% NON-CONDENSING

Voltage: 3.3V

Board Power Dissipation: 6.89W

#### Disclaimers

Asterisk® is a registered trademark of Digium, Inc.

## 1.2 What is Asterisk:

The Definition of Asterisk is described as follow:

Asterisk is a complete PBX in software. It runs on Linux, BSD, Windows (emulated) and provides all of the features you would expect from a PBX and more. Asterisk does voice over IP in four protocols, and can interoperate with almost all standards-based telephony equipment using relatively inexpensive hardware.

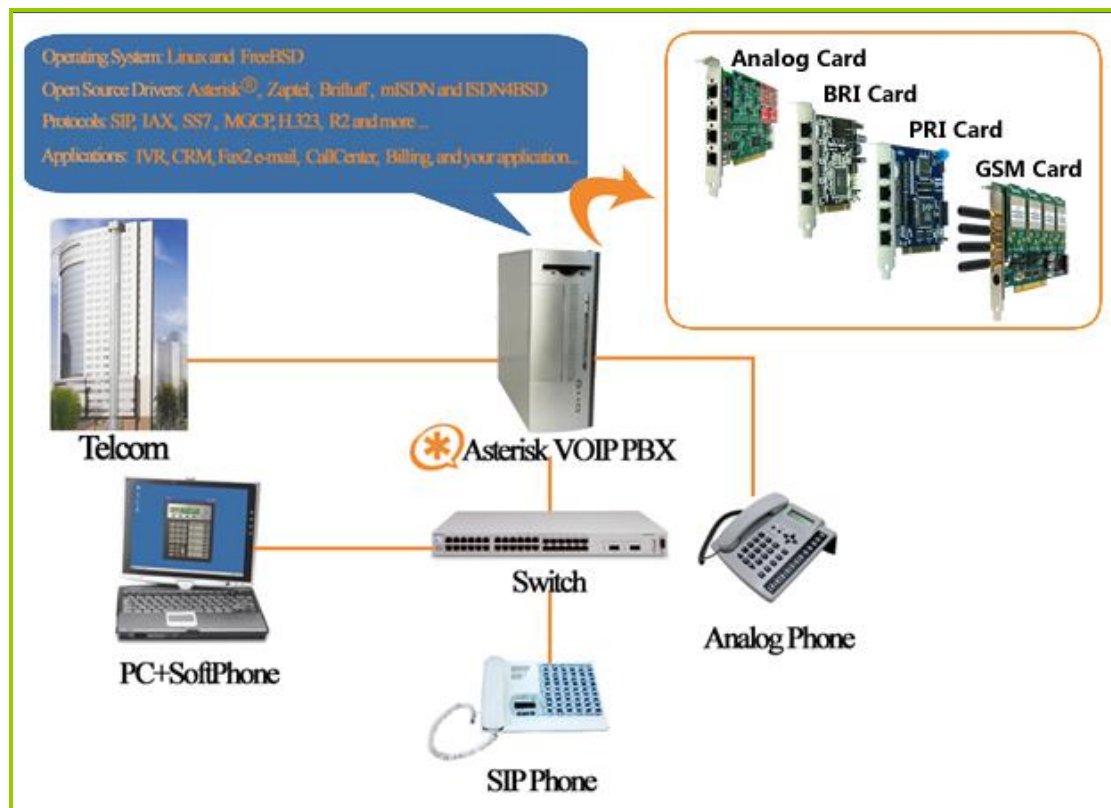

Figure 1: Asterisk\_OpenVox Setup

Asterisk provides Voicemail services with Directory, Call Conferencing, Interactive Voice Response, Call Queuing. It has support for three-way calling, caller ID services, ADSI, IAX, SIP, H.323 (as both client and gateway), MGCP (call manager only) and SCCP/Skinny (voip-info.org).

## 2. Hardware Setting

To set the A2410P/AE2410P, user MUST go through these steps:

1. Checking power supply: **Board must be provided power, please plug the power supply cable into power supply connector.** (refer figure 2)

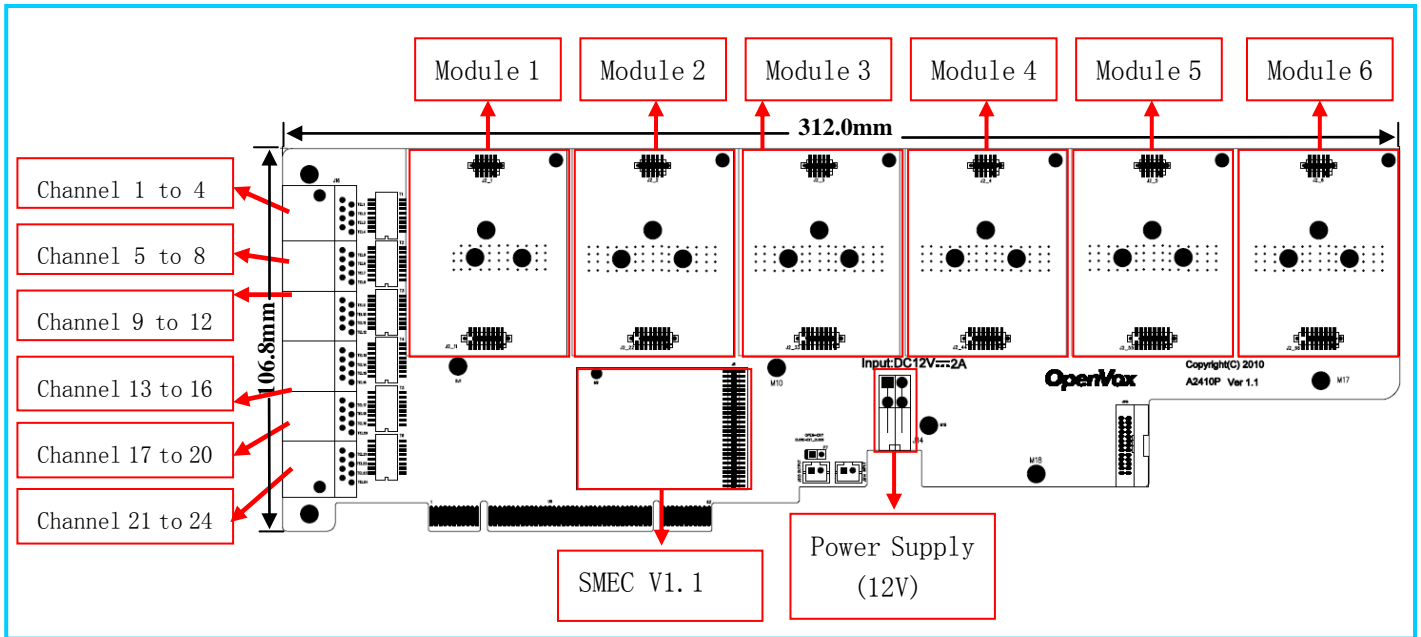

Figure 2: A2410P/AE2410P Hardware Configuration

2. Checking cabling/pin assignment: There are six modules on A2410P/AE2410P, each module (FXS400/FXO400) corresponds one RJ45 interface (refer figure 2). There are eight pins on each RJ45 interface. A2410P/AE2410P uses the two pins of it as a pair, connecting to two-wire telephone line, **so each RJ45 interface can split into four telephone lines.** Please see figure 3 for the setting of A2410P/AE2410P.

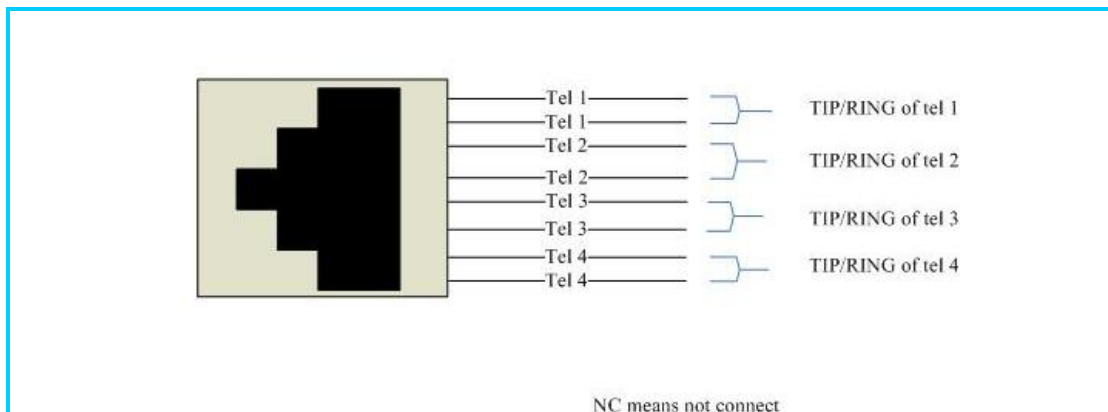

Figure 3: A2410P/AE2410P pin assignment

3. Splitting the RJ45 to RJ11: User has to use a splitter (refer figure 4) to split RJ45 interface to four RJ11 normal telephone line. **And please connect PSTN line into FX0 port and telephone into FXS port.**



Figure 4: A2410P/AE2410P Splitter

### 3. Software Installation and Configuration

After install Elastix 2.0 successfully, to use A2410P/AE2410P on Elastix 2.0, user must download dahdi the same version as on Elastix 2.0, and recompile dahdi. Take Elastix 2.0.1 for example, dahdi version on Elastix 2.0.1 is 2.3.0.1, so user must download dahdi 2.3.0.1 and recompile dahdi.

#### 3.1 Download dahdi and driver

1. Check the version of dahdi  

```
modinfo /lib/modules/`uname -r`/dahdi/dahdi.ko
```
2. Download dahdi from:  
<http://downloads.asterisk.org/pub/telephony/>
3. Download A2410P/AE2410P driver from:  
[http://downloads.openvox.cn/pub/drivers/dahdi-patches/a2410p/opvxa24xx\\_dahdi-linux.tar.gz](http://downloads.openvox.cn/pub/drivers/dahdi-patches/a2410p/opvxa24xx_dahdi-linux.tar.gz)  
copy the tar file to /dahdi-xx/linux/drivers/dahdi/

#### 3.2 Edit the configure file

To edit the configure file, user must follow these steps:

1. Add opvxa24xx in /usr/src/dahdi-xx/linux/build\_tools/live\_dahdi  
add opvxa24xx shown in red

---

```
MODULES_LOAD="$MODULES_LOAD xpp/xpp_usb"
;;
wctdm24xxp | wct4xxp | wctel2xp | wctc4xp | opvxa24xx)
MODULES_LOAD="$MODULES_LOAD $mod/$mod"
```

---

2. Add opvxa24xx in /usr/src/dahdi-xx/linux/drivers/dahdi/Kbuild

---

```
obj-$(DAHDI_BUILD_ALL)$ (CONFIG_DAHDI_WCT4XXP) += wct4xxp/
obj-$(DAHDI_BUILD_ALL)$ (CONFIG_DAHDI_WCT4XXP) += opvxa24xx/
obj-$(DAHDI_BUILD_ALL)$ (CONFIG_DAHDI_WCTC4XXP) += wctc4xxp/
```

---

3. Add opvxa24xx in /usr/src/dahdi-xx/linux/drivers/dahdi/Kconfig



---

```

config DAHDI_WCT4XXP
tristate "Digium Wildcard dual- and quad-T1/E1/J1 Support"
depends on DAHDI && PCI
default DAHDI
---help---
  This driver provides support for the following Digium
  Wildcard products:

  * TE205/206/207/210/211/212P (PCI/PCI-X)
  * TE220 (PCI-E)
  * TE405/406/407/410/411/412P (PCI/PCI-X)
  * TE420 (PCI-E)

  To compile this driver as a module, choose M here: the
  module will be called wct4xxp.

  If unsure, say Y.
```

```

config DAHDI_OPVXA24XX
tristate "OpenVox 24 ports analog card Support"
depends on DAHDI && PCI
default DAHDI
---help---
  This driver provides support for the following OpenVox
  Wildcard products:
  * A2410P (PCI)

  To compile this driver as a module, choose M here: the
  module will be called opvxa24xx.

  If unsure, say Y.
```

---

4. Add opvxa24xx in `/usr/src/dahdi-xx/tools/xpp/perl_modules/Dahdi/Hardware/PCI.pm`

---

```

# from opvxa24xx
'1b74:2410' => { DRIVER => 'opvxa24xx', DESCRIPTION => 'OpenVox A2410P' },

# from wctdm24xxp
'd161:2400' => { DRIVER => 'wctdm24xxp', DESCRIPTION => 'Wildcard TDM2400P' },
'd161:0800' => { DRIVER => 'wctdm24xxp', DESCRIPTION => 'Wildcard TDM800P' },
```

---

5. Add opvxa24xx in `/usr/src/dahdi-xx/tools/xpp/perl_modules/Dahdi/Chans.pm`

---

```

my $dahdi_cfg = $ENV{DAHDI_CFG} || '/usr/sbin/dahdi_cfg';
sub probe_type($) {
  my $self = shift;
  my $fqm = $self->fqm;
  my $num = $self->num;
  my $type;

  if($fqm =~ m:WCTDM/|WRTDM/|OPVXA1200/|OPVXA24XX/;) {
```

```

my %maybe;

undef %maybe;
foreach my $sig (qw(fxo fxs)) {
    my $cmd = "echo ${sig}ks=$num | $dahdi_cfg -c /dev/fd/0";

    $maybe{$sig} = system("$cmd >/dev/null 2>&1") == 0;
}

```

6. Add opvxa24xx in /usr/src/dahdi-xx/tools/modules.sample

```

# Digium TE205P/TE207P/TE210P/TE212P: PCI dual-port T1/E1/J1
# Digium TE405P/TE407P/TE410P/TE412P: PCI quad-port T1/E1/J1
# Digium TE220: PCI-Express dual-port T1/E1/J1
# Digium TE420: PCI-Express quad-port T1/E1/J1
wct4xxp

# OpenVox A2410P: up to 24 analog ports
opvxa24xx

```

7. Add opvxa24xx in /usr/src/dahdi-xx/tools/blacklist.sample

```

blacklist wctdm
blacklist opvxa24xx
blacklist wctc4xxp
blacklist wcb4xxp

```

### 3.3 Installation

User can install the driver via the following steps (assuming user has the source code of dahdi device driver installed in /usr/src/dahdi-2.2.XX directory):

1. Checking the A2410P/AE2410P hardware by command: **lspci -vvvvv**

From the following, user can see that there is a device called communication controller interface be found.

```

01:01.0 Communication controller: Unknown device 1b74:2410 (rev 01)
    Subsystem: Unknown device 1b74:0001
    Control: I/O+ Mem+ BusMaster+ SpecCycle- MemWINV+ VGASnoop- ParErr- Stepping- SERR-
FastB2B-
    Status: Cap- 66MHz- UDF- FastB2B- ParErr- DEVSEL=slow >TAbort- <TAbort-
<MAbort- >SERR- <PERR-
    Latency: 64, Cache Line Size: 16 bytes
    Interrupt: pin A routed to IRQ 50
    Region 0: Memory at dcd00000 (32-bit, non-prefetchable) [size=1M]

```

## 2. Compiling

execute the commands:

```
cd /usr/src/dahdi-linux-complete-XX
./configure
make
make install
make config
```

## 3.4 Configure

### 1. Loading modules for opvxa24xx:

```
modprobe dahdi
modprobe opvxa24xx opermode=YOUR COUNTRY
dahdi_genconf
dahdi_cfg -vvvv
```

Then run **dmesg**

If user uses AE2410P, from the following, user can find EC module has been detected.

---

```
OpenVox A2410P version: 1.0
Module 0: Installed -- AUTO FXO (FCC mode)
Module 1: Installed -- AUTO FXO (FCC mode)
Module 2: Installed -- AUTO FXO (FCC mode)
Module 3: Installed -- AUTO FXO (FCC mode)
Module 4: Installed -- AUTO FXS/DPO
Module 5: Installed -- AUTO FXS/DPO
Module 6: Installed -- AUTO FXS/DPO
Module 7: Installed -- AUTO FXS/DPO
Module 8: Installed -- AUTO FXO (FCC mode)
Module 9: Installed -- AUTO FXO (FCC mode)
Module 10: Installed -- AUTO FXO (FCC mode)
Module 11: Installed -- AUTO FXO (FCC mode)
Module 12: Installed -- AUTO FXS/DPO
Module 13: Installed -- AUTO FXS/DPO
Module 14: Installed -- AUTO FXS/DPO
Module 15: Installed -- AUTO FXS/DPO
Module 16: Installed -- AUTO FXO (FCC mode)
Module 17: Installed -- AUTO FXO (FCC mode)
Module 18: Installed -- AUTO FXO (FCC mode)
Module 19: Installed -- AUTO FXO (FCC mode)
Module 20: Installed -- AUTO FXS/DPO
Module 21: Installed -- AUTO FXS/DPO
Module 22: Installed -- AUTO FXS/DPO
Module 23: Installed -- AUTO FXS/DPO
VPM450: echo cancellation supports 32 channels
VPM450: echo cancellation for 32 channels
VPM450: hardware DTMF disabled.
VPM450: Present and operational servicing 1 span(s)
```

---

### 2. Checking the configure files

The command **dahdi\_genconf** will automatically generate the system.conf under /etc/dahdi and dahdi-channels.conf under /etc/asterisk. Please check the setting of system.conf, it looks like the following:

---

```
# Autogenerated by /usr/sbin/dahdi_genconf on Thu Jul 22 00:56:58 2010
# If you edit this file and execute /usr/sbin/dahdi_genconf again,
# your manual changes will be LOST.
# Dahdi Configuration File
#
# This file is parsed by the Dahdi Configurator, dahdi_cfg
#
# Span 1: OPVXA24XX/24 "OpenVox A2410 Board 25" (MASTER)
fxsks=1
fxsks=2
fxsks=3
fxsks=4
fxoks=5
fxoks=6
fxoks=7
fxoks=8
. -----> part of the file
.
.
```

# Global data

```
loadzone      = us      ;Please change to your country
defaultzone   = us      ;Please change to your country
```

---

Edit /etc/asterisk/indications.conf

---

```
country = us      ;Please change to your country
```

---

File dahdi-channels.conf should look like the following:  
FX0 ports use FXS signaling, the configure file looks like this:

---

```
; Autogenerated by /usr/sbin/dahdi_genconf on Thu Jul 22 00:56:58 2010
; If you edit this file and execute /usr/sbin/dahdi_genconf again,
; your manual changes will be LOST.
; Dahdi Channels Configurations (chan_dahdi.conf)
;
; This is not intended to be a complete chan_dahdi.conf. Rather, it is intended
; to be #include-d by /etc/chan_dahdi.conf that will include the global settings
;
; Span 1: OPVXA24XX/24 "OpenVox A2410 Board 25" (MASTER)
;;; line="1 OPVXA24XX/24/0"
signalling=fxs_ks
callerid=asreceived
group=0
context=from-pstn
channel => 1
callerid=
group=
context=default

;;; line="2 OPVXA24XX/24/1"
signalling=fxs_ks
callerid=asreceived
group=0
context=from-pstn
channel => 2
callerid=
group=
context=default
```

---

FXS ports use FXO signalling, the configure file looks like this:

---

```
;;; line="5 OPVXA24XX/24/4"
signalling=fxo_ks
callerid="Channel 5" <4005>
mailbox=4005
group=5
context=from-internal
channel => 5
callerid=
mailbox=
group=
context=default

;;; line="6 OPVXA24XX/24/5"
signalling=fxo_ks
callerid="Channel 6" <4006>
mailbox=4006
group=5
context=from-internal
channel => 6
callerid=
mailbox=
group=
context=default
```

---

### 3. Starting asterisk

Checking the dahdi channel loading from asterisk console:

**asterisk - vvvvvvvgc**

Entering asterisk console, run command: **dahdi show channels**. If dahdi channels can be shown, which means the dahdi channels have been loaded into asterisk.

---

```
*CLI> dahdi show channels
```

Chan	Extension	Context	Language	MOH Interpret	Blocked	State
Pseudo		default		default		In service
1		from-pstn		default		In service
2		from-pstn		default		In service
3		from-pstn		default		In service
4		from-pstn		default		In service
5		from-internal		default		In service
6		from-internal		default		In service
7		from-internal		default		In service
8		from-internal		default		In service
9		from-pstn		default		In service
10		from-pstn		default		In service
11		from-pstn		default		In service
12		from-pstn		default		In service
13		from-internal		default		In service
14		from-internal		default		In service
15		from-internal		default		In service
16		from-internal		default		In service
17		from-pstn		default		In service
18		from-pstn		default		In service
19		from-pstn		default		In service
20		from-pstn		default		In service
21		from-internal		default		In service
22		from-internal		default		In service
23		from-internal		default		In service
24		from-internal		default		In service

---

The status of channel looks like the following. If user uses AE2410P, EC Status of active channel should be ON; otherwise it would be OFF.

---

```
*CLI> dahdi show channel 4
```

```
Channel: 4
File Descriptor: 19
Span: 1
Extension:
Dialing: no
Context: from-pstn
Caller ID:
Calling TON: 0
Caller ID name:
Mailbox: none
Destroy: 0
InAlarm: 0
Signalling Type: FXS Kewlstart
Radio: 0
Owner: DAHDI/4-1
```

Real: DAHDI/4-1  
Callwait: <None>  
Threeway: <None>  
Confno: -1  
Propagated Conference: -1  
Real in conference: 0  
DSP: yes  
Busy Detection: no  
TDD: no  
Relax DTMF: no  
Dialing/CallwaitCAS: 0/0  
Default law: ulaw  
Fax Handled: no  
Pulse phone: no  
DND: no  
Echo Cancellation:  
    128 taps  
    currently ON  
Master Channel: 24  
Actual Confinfo: Num/24, Mode/0x0009  
Actual Confmute: No  
Hookstate (FXS only): Offhook

---

## 4. Configure on Elastix webpage

### 4.1 Log into Elastix Webpage

Please open your browser and enter the PBX IP address, then input Username: admin; Password: the password is the one user sets when install Elastix 2.0, then click on Submit button in the following screen.

### 4.2 Create Extensions

Add two extensions, then user can plug two phones to FXS, after that the two phones can call each other.

- 1) Click PBX button in the following illustration:

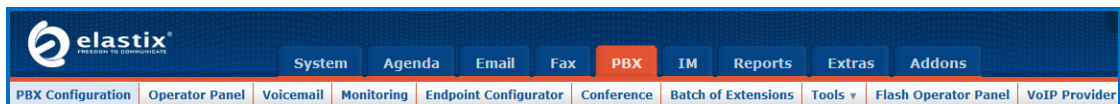

- 2) Click on Extensions bar in the following illustration:

From the drop down selection box, select Generic Zap Device since we are going to create zap extension, then click on submit button. Please refer to the following illustration:



Option	<h2>Add an Extension</h2> <p>Please select your Device below then click Submit</p> <p>Device</p> <hr/> <p>Device</p> <div style="border: 1px solid black; padding: 2px;">             Generic ZAP Device              Generic SIP Device              Generic IAX2 Device              Generic ZAP Device              Other (Custom) Device              None (virtual exten)         </div> <p><input type="button" value="Submit"/></p>
Unembedded freePBX	
Basic	
Extensions	
Feature Codes	
General Settings	
Outbound Routes	
Trunks	
Inbound Call Control	
Inbound Routes	
Announcements	

- 3) Set up User Extension: 111 (that's the extension number I gave for reception); Display Name: 111 in the following illustration:

**Add Extension**

---

User Extension

Display Name

CID Num Alias

SIP Alias

- 4) Input a channel number for your extension, please refer to the following illustration.:

**Device Options**

---

This device uses zap technology. (Via DAHDI compatibility mode)

channel

- 5) Then click on submit button.

Press 0:   Go To Operator

Press 1:

Press 2:

- 6) Click the “Apply Configuration Changes Here” bar in the top of the screen.



- 7) If user have FXS modules on AE2410P, please follow these steps. Otherwise, please jump to 8)

- a) Click extension 111 in the following illustration:

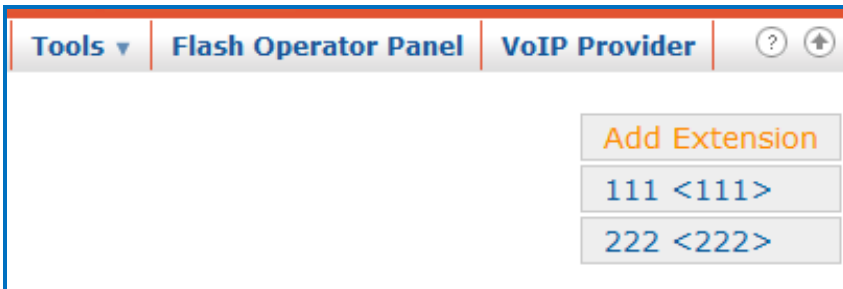

- b) Please set echocancelwhenbridged to yes in the following illustration:

Device Options

---

This device uses zap technology. (Via DAHDI compatibility mode)

channel	<input type="text" value="5"/>
context	<input type="text" value="from-internal"/>
immediate	<input type="text" value="no"/>
signalling	<input type="text" value="fxo_ks"/>
echocancel	<input type="text" value="yes"/>
echocancelwhenbridged	<input type="text" value="yes"/>
echotraining	<input type="text" value="800"/>

- c) Then click on submit button.

Press 0:   Go To Operator

Press 1:

Press 2:

- d) Click the “Apply Configuration Changes Here” bar in the top of the screen.

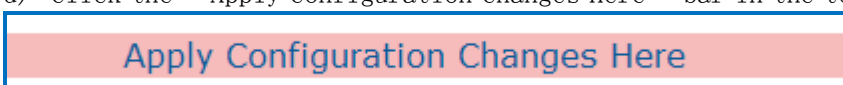

- 8) Please repeat the above steps to add another extension 222 on channel 6. After these, we can dial each other between 111 and 222.

### 4.3 Add Incoming Route

Add an incoming route, it will help you get incoming calls.

- 1) Click on “Inbound Routes” bar.

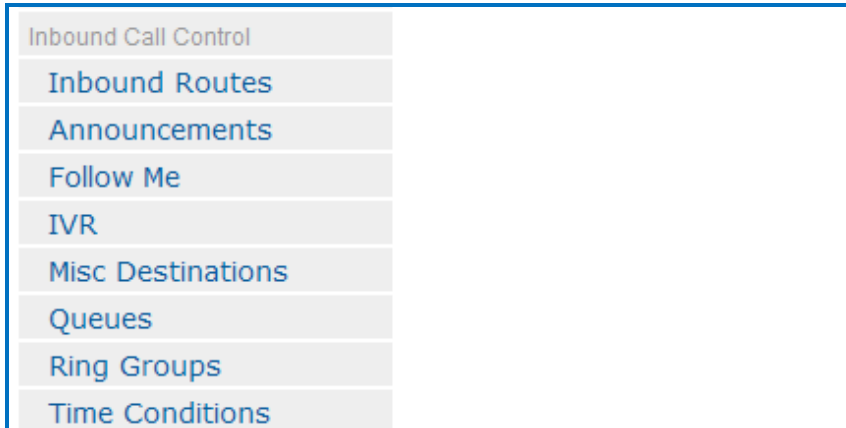

- 2) Input incoming1 in the textbox of Description as the following screen:

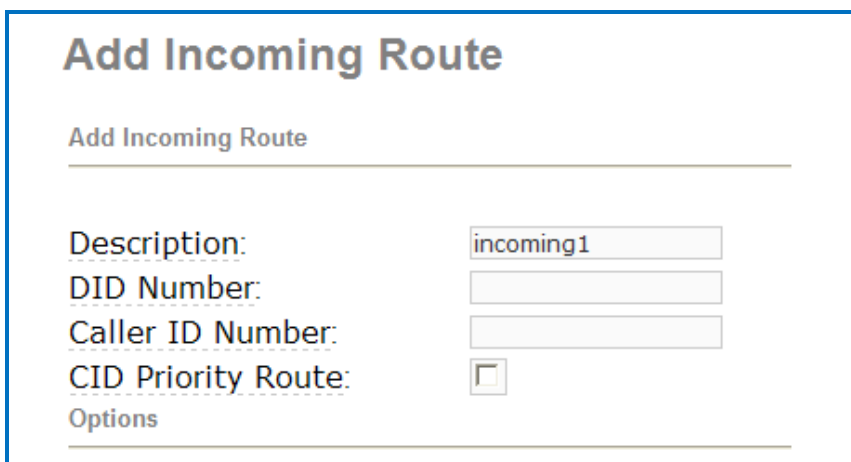

- 3) Click the Extensions textbox, choose an extension number from the drop down selection box. Then click submit. Please refer to the following illustration:

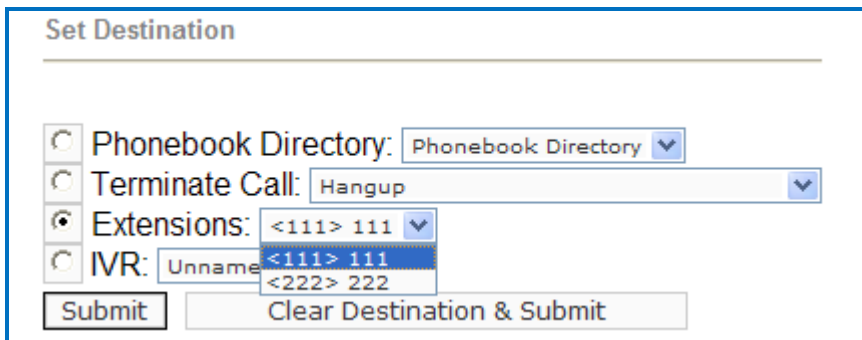

- Click the “Apply Configuration Changes Here” bar in the top of the screen.

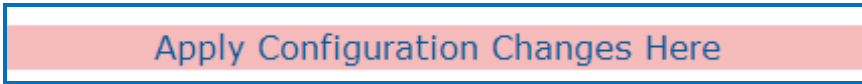

#### 4.4 Create Trunk

To dial out, you have to create trunk.

- Click on Trunks bar as the following illustration:

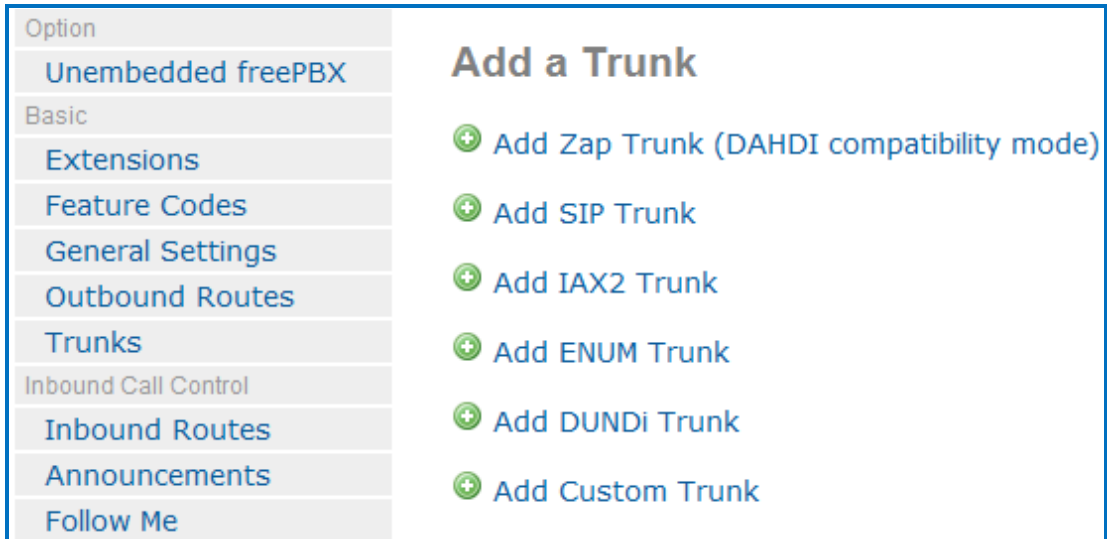

- Click on Trunk ZAP/g0 button on the up right corner of the page, please refer to the following illustration:

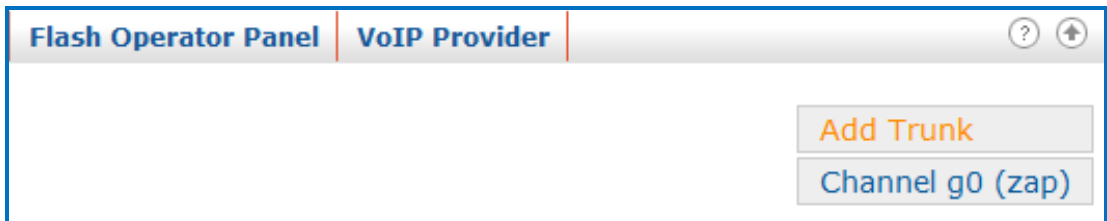

- Input trunk1 in the textbox of Outbound Caller ID, please refer to the following illustration:

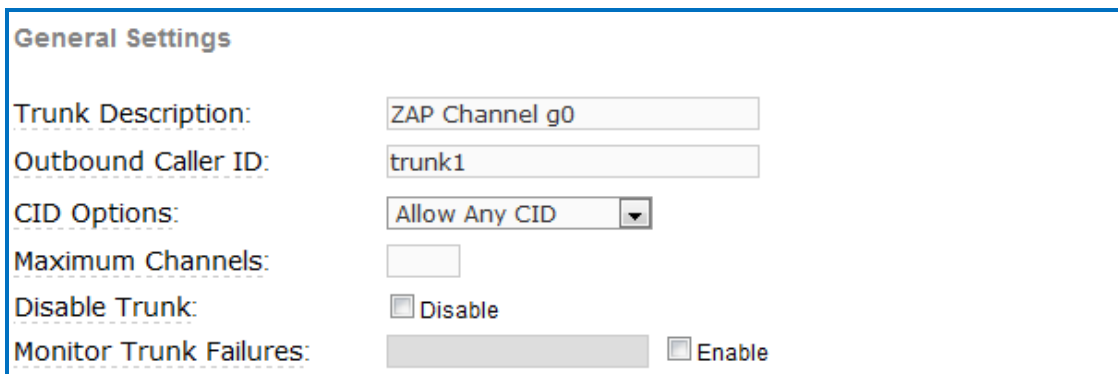

- 4) Click on Submit Changes button in the following screen:

**Outgoing Settings**

Zap Identifier (trunk name):

- 5) Click the “Apply Configuration Changes Here” bar in the top of the screen.

Apply Configuration Changes Here

### 4.5 Set up Outbound Route

Through outbound routes, user can dial out.

- 1) Please click on the Outbound Routes as the following illustration:

<div style="border-bottom: 1px solid gray; padding: 2px;">Option</div> <div style="border-bottom: 1px solid gray; padding: 2px; color: blue;">Unembedded freePBX</div> <div style="border-bottom: 1px solid gray; padding: 2px;">Basic</div> <div style="border-bottom: 1px solid gray; padding: 2px; color: blue;">Extensions</div> <div style="border-bottom: 1px solid gray; padding: 2px; color: blue;">Feature Codes</div> <div style="border-bottom: 1px solid gray; padding: 2px; color: blue;">General Settings</div> <div style="border-bottom: 1px solid gray; padding: 2px; color: blue;">Outbound Routes</div> <div style="padding: 2px;">Trunks</div>	<h3 style="margin: 0;">Add Route</h3> <p>Route Name: <input style="width: 100%;" type="text"/></p> <p>Route CID: <input style="width: 90%;" type="text"/> <input type="checkbox"/> Override Extension CID</p> <p>Route Password: <input style="width: 90%;" type="text"/></p> <p>PIN Set: <input style="width: 50%;" type="text" value="None"/> ▾</p> <p>Emergency Dialing: <input type="checkbox"/></p>
--	--

- 2) Please click “09\_outside button”, keep the default parameters in the following screen. Please refer to the following illustration:

### Edit Route

Add Route  
0 9\_outside

⊖ Delete Route 9\_outside

Route Name: 9\_outside Rename

Route CID:   Override Extension CID

Route Password:

PIN Set: None ▾

Emergency Dialing:

Intra Company Route:

Music On Hold?: default ▾

Dial Patterns

9|.

Clean & Remove duplicates

Dial patterns wizards: (pick one) ▾

Trunk Sequence

0 ZAP/g0 ▾

Add

Submit Changes

Here we use the default Dial Pattern 9|., so we have to add prefix 9, when we dial out. For example, if you want to call 123456, then you have to press 9123456 on your phone.

- 3) Click the “Apply Configuration Changes Here” bar in the top of the screen.

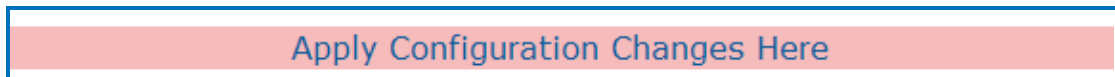

**Notes:**

**Test environments are:**

- Elastix 2.0.1
- Kernel version: 2.6.18-194.3.1.el5
- Dahdi: dahdi-linux-complete-2.3.0.1+2.3.0
- Asterisk: 1.6.2.10
- Hardware: OpenVox A2410P/AE2410P

## 5. References

[www.openvox.cn](http://www.openvox.cn)

[www.digium.com](http://www.digium.com)

[www.asterisk.org](http://www.asterisk.org)

[www.voip-info.org](http://www.voip-info.org)

[www.asteriskguru.com](http://www.asteriskguru.com)