



**OpenVox Communication Co.Ltd**



## **B100M on DAHDI User Manual**

Version: 2.2





**OpenVox Communication Co.Ltd**

***OpenVox-Best Cost Effective Asterisk Cards***

Address: F/3, Building No.127, Jindi Industrial Zone,  
Shazui Road, Futian District, Shenzhen, Guangdong 518048, China  
Tel:+86-755-82535461, 82535095, 82535362, Fax:+86-755-83823074

Business Contact: [sales@OpenVox.com.cn](mailto:sales@OpenVox.com.cn)  
Technical Support: [support@OpenVox.com.cn](mailto:support@OpenVox.com.cn)

Business Hours: 09:00-18:00(GMT+8) from Monday to Friday  
URL: [www.OpenVox.cn](http://www.OpenVox.cn)

***Thank You for Choosing OpenVox Products!***

## **Copyright**

Copyright© 2011 OpenVox Inc. All rights reserved. No part of this document may be reproduced without prior written permission.

## **Confidentiality**

Information contained herein is of a highly sensitive nature and is confidential and proprietary to OpenVox Inc. No part may be distributed, reproduced or disclosed orally or in written form to any party other than the direct recipients without the express written consent of OpenVox Inc.

## **Disclaimer**

OpenVox Inc. reserves the right to modify the design, characteristics, and products at any time without notification or obligation and shall not be held liable for any error or damage of any kind resulting from the use of this document.

OpenVox has made every effort to ensure that the information contained in this document is accurate and complete; however, the contents of this document are subject to revision without notice. Please contact OpenVox to ensure you have the latest version of this document.

## **Trademarks**

All other trademarks mentioned in this document are the property of their respective owners.

# Contents

<b>General Safety Instructions .....</b>	<b>4</b>
<b>Test Environments .....</b>	<b>5</b>
<b>Chapter 1 Overview.....</b>	<b>6</b>
1.1 What is Asterisk .....	6
1.2 What is B100M .....	7
<b>Chapter 2 Hardware Setup .....</b>	<b>9</b>
2.1 Power supply .....	9
2.2 Slot compatibility .....	9
2.3 Adjusting Termination of S/T Interface (100 ohm).....	10
2.4 Hardware setup procedure .....	11
<b>Chapter 3 Software Installation and Configuration.....</b>	<b>13</b>
3.1 Download .....	13
3.2 Installation.....	15
3.3 Configuration .....	19
<b>Chapter 4 Reference .....</b>	<b>24</b>
<b>Appendix A Specifications .....</b>	<b>25</b>
<b>Appendix B PIN Assignments .....</b>	<b>26</b>



## General Safety Instructions



### CAUTION

1. The computers that have B100M card installed must comply with the country's specific safety regulations.
2. Only service personnel should install B100M card.
3. Before you install B100M card, please unplug the power cord from the computer and remove the cover from your PC.
4. For avoiding personal injuries and damage to your computer and B100M card, make sure bracket of the card is secured to the PC's chassis ground by fastening the card with screws.
5. Electrical Surges, ESD are very destructive to the equipment. To avoid it, make sure there is a low impedance discharge path from your computer to chassis ground.
6. To reduce the risk of damage or injury, please follow all steps or procedures as instructed.

## Test Environments

CentOS-5.6

Kernel version: 2.6.18-238.12.1.el5

DAHDI: dahdi-linux-complete-current

Asterisk: 1.8.4.4

Libpri: 1.4.11.5

Hardware: OpenVox B100M

## Chapter 1 Overview

### 1.1 What is Asterisk

The Definition of Asterisk is described as follows:

Asterisk is a complete PBX in software. It runs on Linux, BSD, Windows (emulated) and provides all of the features you would expect from a PBX and more. Asterisk does voice over IP in four protocols, and can interoperate with almost all standard-based telephony equipments using relatively cost-effective hardware. Asterisk provides Voicemail services with Directory, Call Conferencing, Interactive Voice Response, and Call Queuing. It supports three-way calling, caller ID services, ADSI, IAX, SIP, H323 (as both client and gateway), MGCP (call manager only) and SCCP/Skinny (voip-info.org).

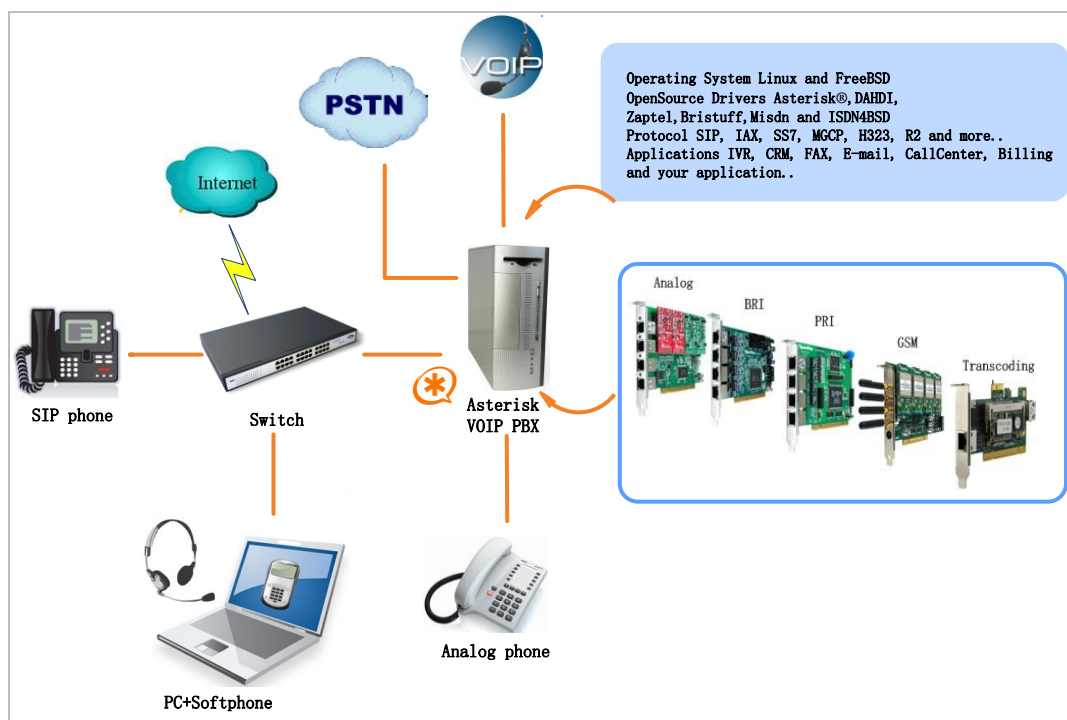

Figure 1 Topology

## 1.2 What is B100M

OpenVox B100M consists of two parts: the B100MM and the B100MS. The B100MM connects Mini PCI slot while the B100MS provides S/T BRI interface connection. The B100M provides 1 port of S/T BRI interface. The BRI port can be set to TE or NT mode by jumpers. This port configuration is detected automatically by the driver.

B100M S/T BRI interface card delivers great voice quality in the telephony systems. It can provide 2 simultaneous voices calls over 1 ISDN BRI line, turns your legacy ISDN BRI equipments into powerful Voice over IP devices and provides a soft migration path from ISDN technology to the new Voice over IP world. B100M is designed for building Open Source systems based on Asterisk such as ISDN PBX and VoIP gateway.

The B100M and drivers comply with fully GPLed for the Linux kernel bring powerful ISDN BRI connectivity to your Linux machine.

B100M works well with Asterisk<sup>®</sup>, Elastix<sup>®</sup>, FreeSWITCH<sup>™</sup>, PBX in a Flash, trixbox<sup>®</sup>, Yate<sup>™</sup> and IPPBX/IVR projects as well as other Open Source and proprietary PBX, Switch, IVR, and VoIP gateway applications.

### Target applications

- High Performance ISDN PC Cards



- ISDN PABX for BRI
- VoIP Gateways
- ISDN LAN Routers for BRI
- ISDN Least Cost Routers for BRI
- ISDN Test Equipment for BRI

### **Main features**

- One integrated S/T interfaces
- Support Mini PCI type III
- ITU-T I.430 and TBR 3 certified and S/T ISDN supporting TE/NT mode
- Design for low power systems
- DTMF detection on all B-channels
- Multiparty audio conferences bridge
- Full software and hardware compatible with Junghanns.NET ISDN, mISDN driver, DADHI and so on.
- RoHS compliant
- Certificates: CE, FCC, A-Tick
- trixbox™ Officially Certified
- Elastix® Officially Certified



## Chapter 2 Hardware Setup

There are some points should be paid attention to when setting up B100M.

### 2.1 Power supply

The board is powered by mini PCI slot which provides +3.3V, and it works well on TE mode; but if you need to use NT mode, a power supply converter named PFM100 is necessary to apply together, which can be used for NT mode of B100/200/400M. More information about PFM100 refers to [HERE](#).

### 2.2 Slot compatibility

B100M is compatible with 32-bit 3.3V Mini PCI type III slot.



Figure 2 124 pin Mini-PCI Type III (Amp 1318228-1) connector

The Mini PCI specification uses a subset of the PCI signal set. Mini-PCI is a small form factor version of a PCI card. The Mini-PCI bus only uses 3.3 volts and the 32-bit PCI bus. Mini PCI type III slot is a 124-pin connector used with Type III Mini-PCI cards. The 124-Pin connector accepts a card edge and a board with fingers.

### 2.3 Adjusting Termination of S/T Interface (100 ohm)

You are able to set a port to NT or TE mode, please refer to figure 3 for visualized information.

- If a port works on NT mode, you should set jumper to CONNECT (ON).
- If a port works on TE mode, theoretically it should be set to OPEN (OFF), but it might connect to some non-standard ISDN terminal equipments that do not have terminal resistors, for such equipments, you should set it to CONNECT(ON).

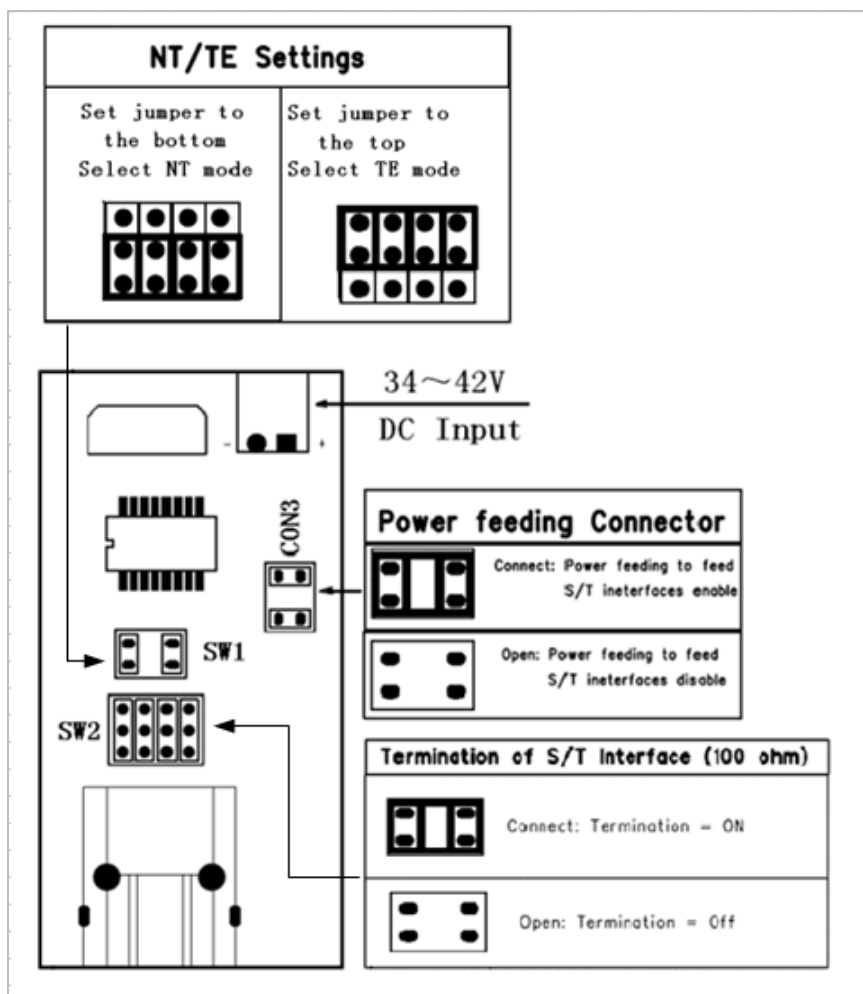

Figure 3 Jumper settings

- Use the cable to connect B100MM and B100MS. On the B100MM, there is a slot for RJ45 expansion board, the slot is used to connect the slot on B100MS. The connection should be:

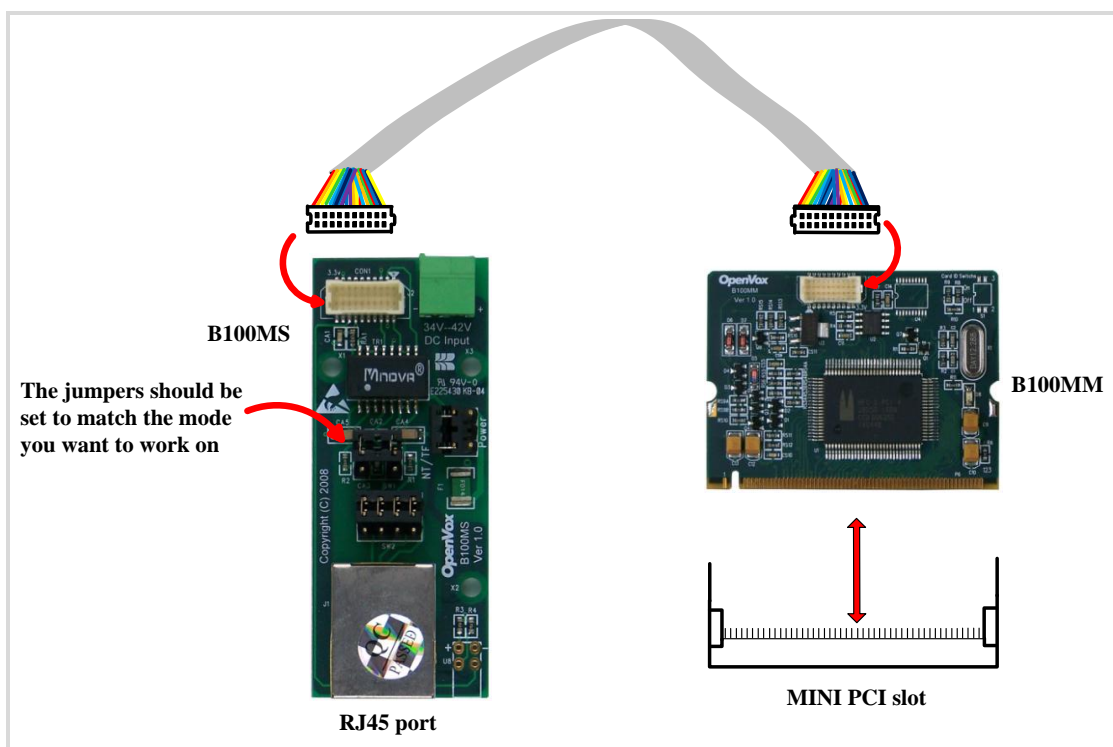

Figure 4 Cable connector

## 2.4 Hardware setup procedure

- Power off your PC, remember to unplug the AC power cable
- Make sure the hardware settings is right
- Insert B100M into a mini PCI slot
- Plug ISDN lines into RJ-45 interfaces which set as TE mode and ISDN phone lines into RJ-45 interface which set as NT mode.
- Fix the board by screws

➤ Power on PC



**Caution:** During the above processes, an ESD wrist strap is needed. Once power is on, you must not attempt to install or take down the board. After hardware setup appropriately, it is time to install software.



## Chapter 3 Software Installation and Configuration

B100M supports DAHDI software driver on Linux. To make full use of B100M, you should download, compile, install and configure DAHDI, Libpri and Asterisk. Let's make specific versions for an example to state how to install software.

### 3.1 Download

DAHDI software packages are available on OpenVox official website or Digium. Some patches should be applied when the driver source is from Digium.

Get DAHDI package from OpenVox official website:

[http://downloads.openvox.cn/pub/drivers/dahdi-linux-complete/openvox\\_dahdi-linux-complete-current.tar.gz](http://downloads.openvox.cn/pub/drivers/dahdi-linux-complete/openvox_dahdi-linux-complete-current.tar.gz)

Get Libpri and Asterisk software packages from:

<http://downloads.asterisk.org/pub/telephony/libpri/releases/libpri-1.4.11.5.tar.gz>

<http://downloads.asterisk.org/pub/telephony/asterisk/releases/asterisk-1.8.4.4.tar.gz>

Execute the following commands under the directory of /usr/src/ in generally to download and decompress these packages:

```
# wget http://downloads.asterisk.org/pub/telephony/libpri/releases/libpri-1.4.11.5.tar.gz

# tar -zxvf libpri-1.4.11.5.tar.gz

# wget http://downloads.openvox.cn/pub/drivers/dahdi-linux-complete/openvox_dahdi-linux-complete-current.tar.gz

# tar -xvzf openvox_dahdi-linux-complete-current.tar.gz

# wget http://downloads.asterisk.org/pub/telephony/asterisk/releases/asterisk-1.8.4.4.tar.gz

# tar -zxvf asterisk-1.8.4.4.tar.gz
```

- If using Asterisk 1.8, it is not need to make any patches more.
- If using Asterisk 1.6, please modify the file asterisk-1.6.xx/channels/chan\_dahdi.c as the following introduction.

Please comment out the following line:

```
/*ast_log(LOG_WARNING, "How cool would it be if someone Implemented this mode!For now, sucks for you.(line %d)\n", v->lineno);*/
```

Then add the following two lines after the above action:

```
confp->chan.sig = SIG_BRI_PTMP;
confp->pri.nodetype = PRI_NETWORK
```

## 3.2 Installation

### 1. Hardware detection

```
# lspci -vvvv
```

Check the outcome and confirm your system has recognized B100M. If it has been recognized, "Network controller" will be displayed in the output information like that:

```
02:0b.0 Network controller: Cologne Chip Designs GmbH ISDN network
controller [HFC-PCI] (rev 02)
    Subsystem: Cologne Chip Designs GmbH ISDN Board
    Control: I/O- Mem+ BusMaster+ SpecCycle- MemWINV- VGASnoop-
ParErr- Stepping- SERR- FastB2B- DisINTx-
    Status: Cap+ 66MHz- UDF- FastB2B- ParErr- DEVSEL=medium
>TAbort- <TAbort- <MAbort- >SERR- <PERR- INTx-
    Latency: 16 (4000ns max)
    Interrupt: pin A routed to IRQ 177
    Region 0: I/O ports at dfe0 [disabled] [size=8]
    Region 1: Memory at feafac00 (32-bit, non-prefetchable)
[size=256]
    Capabilities: [40] Power Management version 1
        Flags: PMEclk- DSI+ D1+ D2+ AuxCurrent=0mA
PME (D0+,D1+,D2+,D3hot+,D3cold-)
        Status: D0 NoSoftRst- PME-Enable- DSel=0 DScale=0
PME-
    Kernel driver in use: vzaphfc
    Kernel modules: zaphfc, hisax
```

Figure 5 Hardware detection

If B100M is not recognized by the system, you have to cut the server power off, take out the card to clean the slot and insert it into the mini PCI slot again.



## 2. Software installation

Some dependencies are crucial. If any of them is absent, the software installation process would not go through successfully. Let's run "yum install XX" (XX stands for the dependency's name) to check the availability of dependencies.

```
# yum install bison
# yum install bison-devel
# yum install ncurses
# yum install ncurses-devel
# yum install zlib
# yum install zlib-devel
# yum install openssl
# yum install openssl-devel
# yum install gnutls-devel
# yum install gcc
# yum install gcc-c++
# yum install libxml2
# yum install libxml2-devel
```

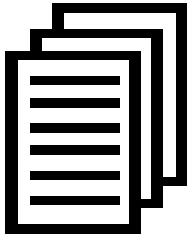

If there is no kernel-devel source in the system, users should run the following command to install the kernel-devel to peer current kernel:

```
# yum install kernel-devel-`uname -r`
```

While if there is no matched kernel-devel found, you should download matched RPM package to install it, or execute the following command to update to the latest and stable kernel version:

```
# yum install kernel kernel-devel
```

After installed, please reboot your machine to apply the new kernel and install the dependencies. If the dependency has been installed, system indicates that nothing to do which means you could go to next one directly. Otherwise, the system will keep on installing it.

Change to the directory of dahdi-linux-complete-XX (XX represents DAHDI version), then perform commands one by one to install DAHDI.

```
# cd /usr/src/dahdi-linux-complete-current
```

```
# make
```

```
# make install
```

```
# make config
```



**Caution:** If there is something wrong after "make", please refer to [HERE](#). In the url link, the moderator introduces you a method how to patch. After patching, save your changes and exit. Then run "make" again, if successfully done, it is time for you to install Libpri and Asterisk.

Please execute those commands to install Libpri and Asterisk:

```
# cd ../libpri-1.4.11.5
# make
# make install

# cd ../asterisk-1.8.4.4
# ./configure
# make
# make install
# make samples
```



"make samples" will install the standard sample configuration file in the directory /etc/asterisk. As a freshman, you should perform "make samples", that is to say, it is unnecessary to perform "make samples" every time.

Because once performed, it will cover the old sample configuration files you have installed.

## 3.3 Configuration

### 1. Driver loading

After compiling and installing DAHDI, Libpri and Asterisk, please load the driver by running commands:

```
# modprobe dahdi
# modprobe zaphfc      (In TE mode)
# dahdi_genconf
# dahdi_cfg -vvv
```

There are two issues for B100M NT mode:

- Sometimes the first call can't work normally, in such cases, it is need to restart Asterisk.
- The system runs "modprobe zaphfc" in default, but it is for TE mode. So it is necessary to run "modprobe zaphfc modes=1 force\_11\_up=0" for NT mode when the machine restarts. After reboot, please run commands:

```
# modprobe -r zaphfc
```

```
# modprobe zaphfc modes=1 force_l1_up=0
```

Or add the following line in the file `/etc/modprobe.conf`:

```
options modprobe zaphfc modes=1 force_l1_up=0
```

After running `"modprobe dahdi"` or `"modprobe zaphfc"`, there is not any information displayed if loaded normally and successfully. `"zaphfc"` is the driver module name of B100M.

If there is any error, please trace the cause. Until all errors are clear up, you could execute `"dahdi_genconf"` again, and then go to the next step.

By running `"dahdi_genconf"`, it will generate `/etc/dahdi/system.conf` and `etc/asterisk/dahdi-channels.conf` automatically. Checking whether the generated files information agrees with your hardware setup, if not, you should modify to your specific requirements. Do not forget to confirm that `dahdi-channels.conf` is included in `chan_dahdi.conf`, if not, run command:

```
# echo "#include dahdi-channels.conf" >>
/etc/asterisk/chan_dahdi.conf
```

A part of `system.conf` which is one of the basic configuration files is

displayed as follows:

```
# Span 1: ZTHFC1 "HFC-S PCI A ISDN card 0 [TE] " (MASTER)
Span=1,1,0,ccs,ami
# termtype: te
bchan=1-2
hardhdlc=3
echocanceller=mg2,1-2

# Global data

loadzone      = us
defaultzone   = us
```

Figure 6 A part of system.conf

## 2. Country mode modification

In order to match your country mode, it is need to change parameters loadzone and defaultzone to your country. For example, your system is in CHINA, you would like them change to:

```
loadzone = cn
```

```
defaultzone = cn
```

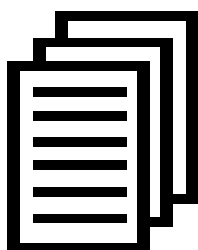

Some zonedata is available in the file

.. /dahdi-XX/tools/zonedata.c, you can refer to it to

match your country mode. Meanwhile, you also need to

modify another parameter which is in file

/etc/asterisk/indications.conf.

```
country=cn
```

A part of file `/etc/asterisk/dahdi-channels.conf` is showed as below.

(Modification, if it is not agree with the hardware setup)

```
; Span 1: ZTHFC1 "HFC-S PCI A ISDN card 0 [TE] " (MASTER)
group=0,11
context=from-isdn
overlapdial=yes      # must add this line
switchtype = euroisdn
signalling = bri_cpe_ptmp
channel => 1-2
context = default
group = 63
```

Figure 7 A part of `dahdi-channels.conf`

### 3. Asterisk initiation

Execute a command to start Asterisk:

```
# asterisk -vvvvvvgc
```

If Asterisk is already activate, run `"asterisk -r"` instead.

In the CLI, please run the following commands

`"dahdi show channels"` and `"pri show spans"`:

```
*CLI> dahdi show channels
  Chan Extension Context Language MOH Interpret Blocked State
pseudo          default default
  1             from-isdn default In Service
  2             from-isdn default In Service
*CLI>
*CLI> pri show spans
PRI span 1/0: Provisioned, Up, Active
*CLI>
```

Figure 8 channels and spans show

If you can see the span is up and active, it means successful installation. Otherwise, please check the setting files and physical connections.

#### 4. Dialplan edit

You should make sure that the context "from-isdn" and "from-internal" are in extensions.conf. Here a simple example is given:

```
# vim /etc/asterisk/extensions.conf
```

```
[from-isdn]
exten => s,1,Dial(SIP/100,,r)
exten => s,n,Hangup()

[from-internal]
exten => _X.,1,Dial(dahdi/1/${EXTEN},,r)
exten => _X.,n,Hangup()
```

Figure 9 dial plan

After saving your dialplan, please run "asterisk -r", then execute "reload" in the CLI. Now you are able to make calls. The above dialplan achieves that:

- If there is a call from the ISDN line, Asterisk will transfer to SIP extension 100, then the SIP phone rings;
- If SIP extension 100 dials any phone number, Asterisk will transfer to the destination phone through the first channel.



## Chapter 4 Reference

[www.OpenVox.cn](http://www.OpenVox.cn)

[www.digium.com](http://www.digium.com)

[www.asterisk.org](http://www.asterisk.org)

[www.voip-info.org](http://www.voip-info.org)

[www.asteriskguru.com](http://www.asteriskguru.com)

### **Tips**

Any questions during installation please consult in our forum or look up for answers from the following websites:

[Forum](#)

[wiki](#)

## Appendix A Specifications

### • Weight and size

Name	Weight	Size
B100MM	10g(0.35oz)	5.9×4.4×0.7cm(2.32×1.73×0.28inch)
B100MS	15g(0.53oz)	6.9×4.1×1.4cm(2.72×1.61×0.55inch)

### • Interfaces

PCI Bus: 3.3V Mini PCI type III slot

Local Loop Access: RJ-45 ports used on certain ISDN S/T/U interfaces

### • Environment

Temperature: 0 ~ 50 °C (Operation) - 40 ~125 °C (Storage)

Humidity: 10 ~ 90% NON-CONDENSING

### • Power consumption

Voltage: 3.3V/5V

Power Dissipation: 0.05W Minimum, 0.13W Maximum

### • Hardware and software requirements

RAM 32 + MB

Linux kernel 2.6.X

CPU 200+ MHZ

## Appendix B PIN Assignments

Basic Rate ISDN lines can use straight ("flat") modular cable if necessary.

However, twisted-pair are more common.

- ISDN U-interface

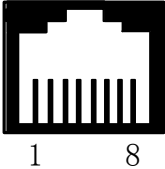
8-pin RJ45 port	PIN	Color	Description
	1	White/Orange	N/A
	2	Orange	N/A
	3	White/Green	N/A
	4	Blue	U interface
	5	White/Blue	U interface
	6	Green	N/A
	7	White/Brown	-48VDC Power (optional)
	8	Brown	-48VDC Return (optional)

The U-Interface is most commonly used in North American Basic Rate ISDN systems. The U-Interface is an 8-conductor, modular, RJ-45 jack.

The center two pins (pin 4 and 5) are used for the 2-wire loop. The wiring of pin 4 and pin 5 **are not** polarity sensitive (e.g. 4 and 5 may be crossed).

Optional -48 VDC power may be utilized on RJ-45 pins 7 and 8. This can be used to power the NT-1 and TE equipments if sufficient power is

available. In most cases, power is **not provided** from the telephone company.

● BRI S-Interface

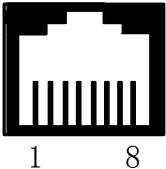
8-pin RJ45 port	PIN	Color	Description
	1	White/Orange	N/A
	2	Orange	N/A
	3	White/Green	Receive+
	4	Blue	Transmit +
	5	White/Blue	Transmit -
	6	Green	Receive -
	7	White/Brown	-48VDC Power(optional)
	8	Brown	-48VDC Return (optional)

The BRI S-Interface is a 4-wire interface, with separate Transmit and Receive pairs. It can be operated in four modes:

- Point-to-Point Mode allows one logical terminal that may be up to 1 KM from the NT-1
- Short Passive Bus Mode allows connection of up to 8 terminals in parallel on the S/T bus. The terminals can be within 100 to 200 meters from the NT-1.

- Extended Passive Bus Mode allows connection to 8 terminals at distances of up to 500 meters from the NT-1.
- Star Bus Mode allows interconnection of up to 8 terminals to a central NT-1. Each terminal can be up to 1 KM from the NT-1.
  - ✧ The NT-1 unit has configurable jumpers to apply a 100-ohm termination to the S-Interface signal pairs. Usually, these jumpers will be in. Rules of termination is similar to that of the SCSI-bus: the NT-1 will have 100-ohm terminators applied, and the farthest TE1/TA device will have 100-ohm terminators.
  - ✧ Optional power to the NT-1 can be applied from pins 7 and 8 of the S-Interface RJ-45 jack. This is usually not used.
  - ✧ Many NT-1 units provide "phantom-power" (sealing current) between the transmit (4,5) and receive (3,6) leads. In these cases, the Transmit (4,5) leads will be negative with respect to the Receive (3,6) leads. This is often selectable in the NT-1. Whenever possible, it is recommended that this option be disabled. As a general rule-of-thumb, most PC cards, routers, and other data communications equipment do not require power from the S/T interface. ISDN telephones usually require power from the S/T interface.
  - ✧ Most NT-1 units will ship with a wall-mount transformer power supply for the NT-1.